

Article number: 208060431

Description: E+G Sphericalwasher female DIN 6319-56-D-NI
Stainless Steel 1.4305

Measures

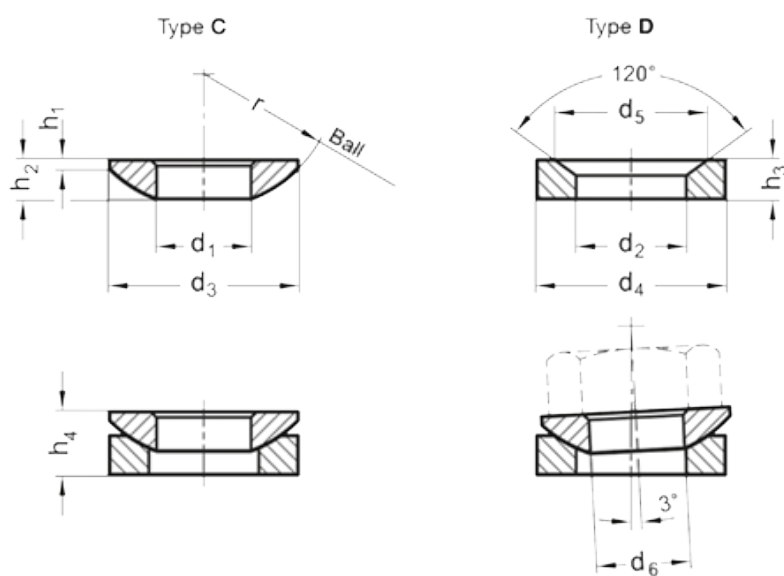

$d_2 = 56.0$

$d_4 = 92$

$d_5 = 82.0$

$d_6 = M48$

$H_3 = 22.0$

$H_4 = 35.5$